

# Intel® Wireless For Desktop Integration Guide

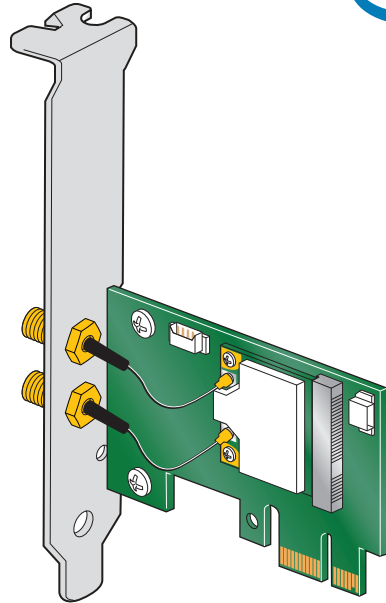

H11842-001

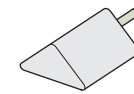
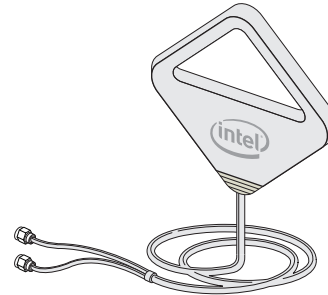
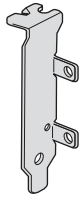
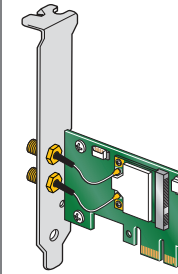
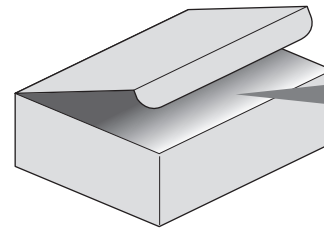

Bluetooth® cable

1

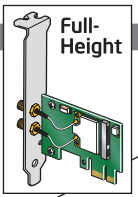

Full-Height

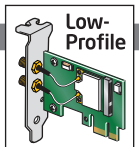

Low-Profile

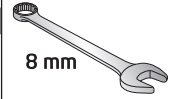

8 mm

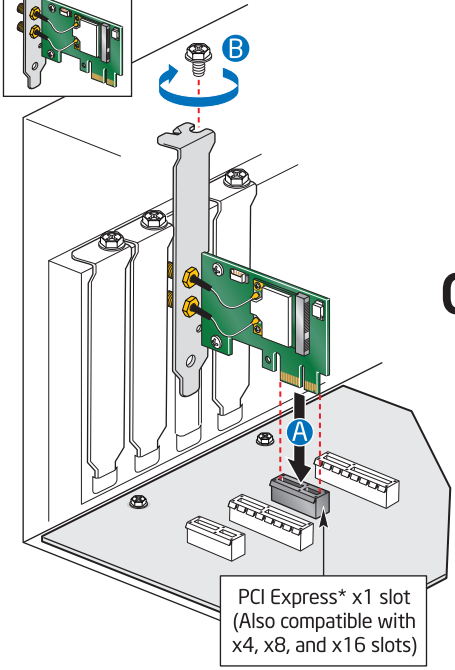
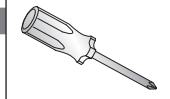

OR

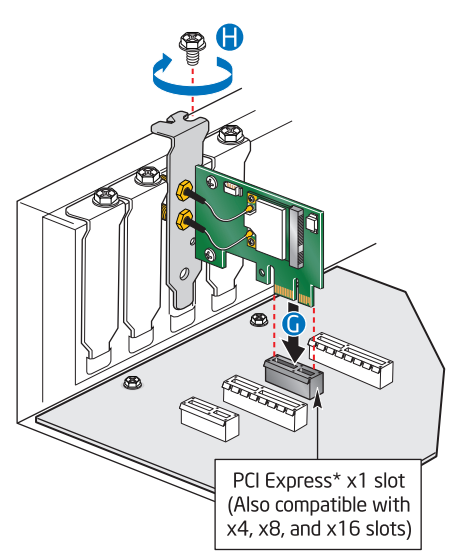
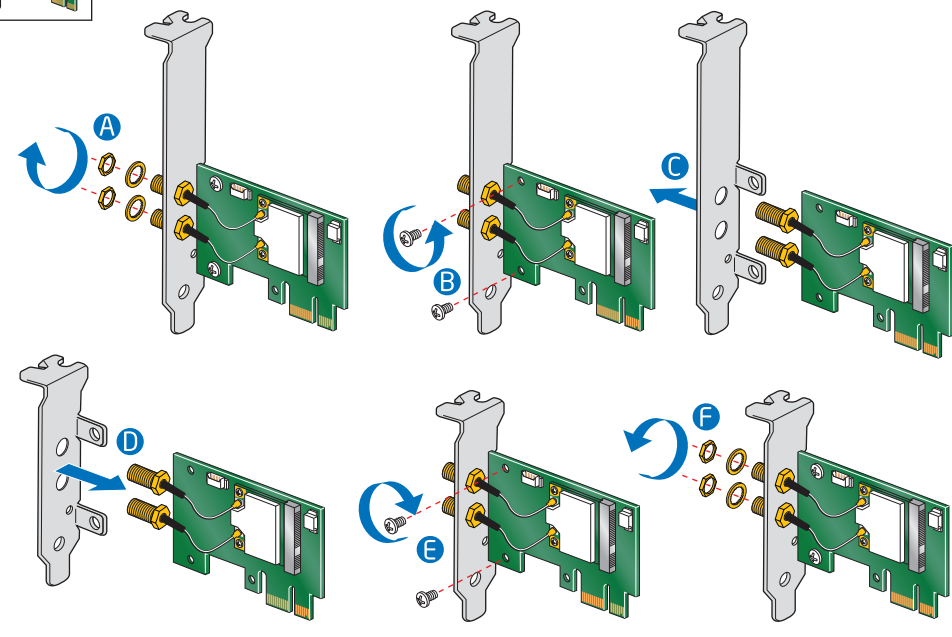

2

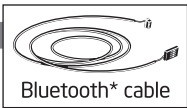

Bluetooth\* cable

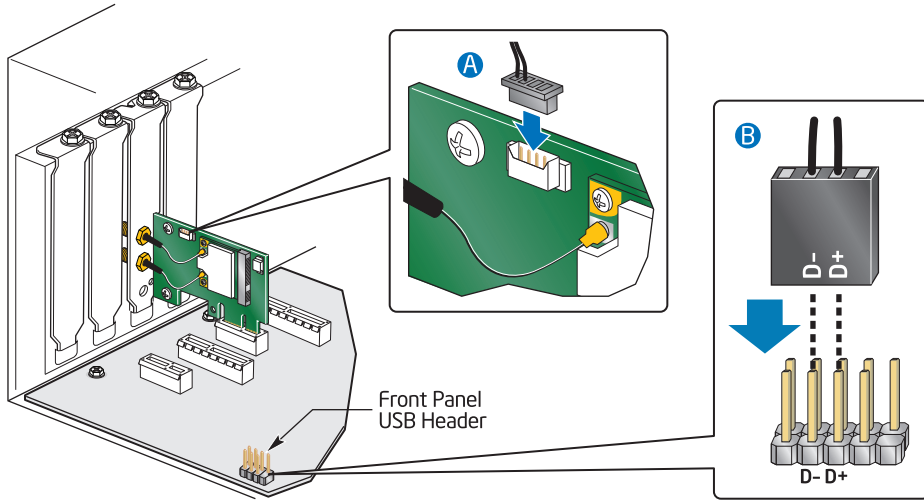

3

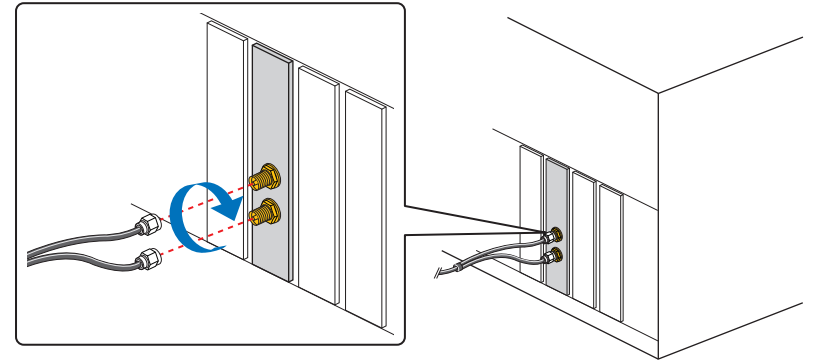
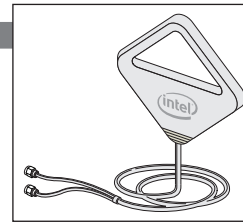

4

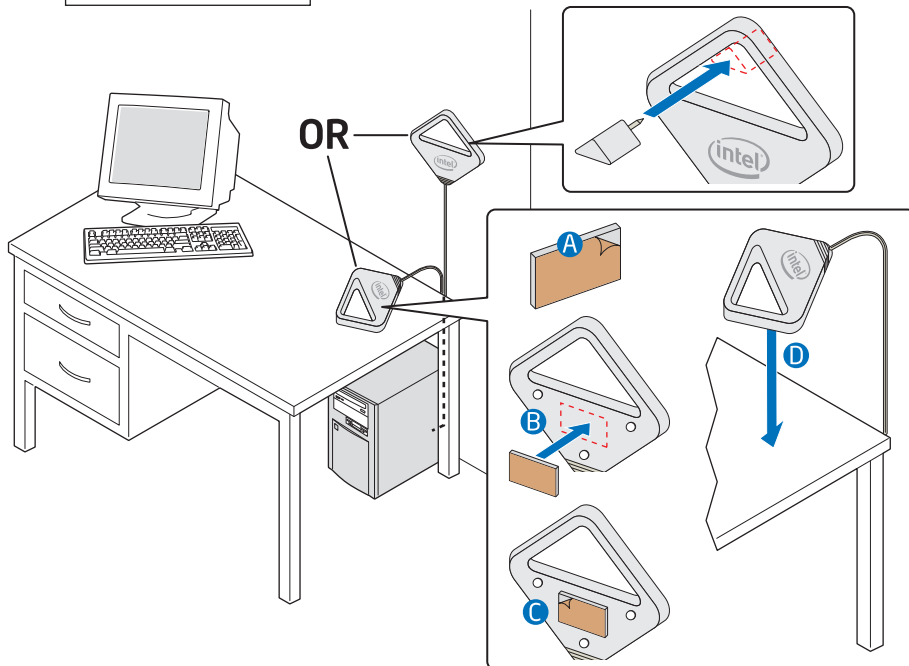
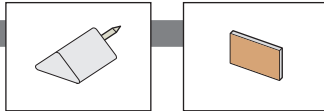
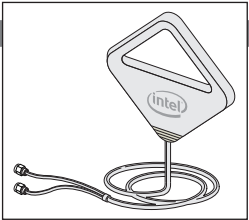

5

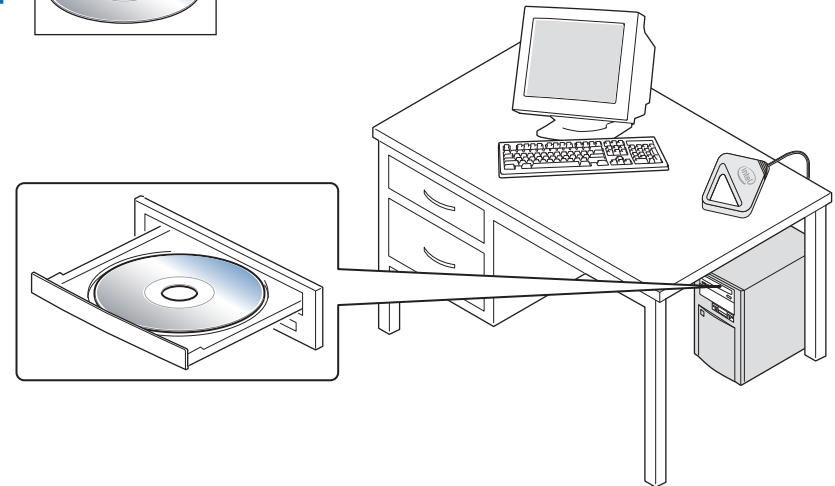

## Support

Customer support: <http://www.intel.com/support>

INFORMATION IN THIS DOCUMENT IS PROVIDED IN CONNECTION WITH INTEL® PRODUCTS. NO LICENSE, EXPRESS OR IMPLIED, BY ESTOPPEL OR OTHERWISE, TO ANY INTELLECTUAL PROPERTY RIGHTS IS GRANTED BY THIS DOCUMENT. EXCEPT AS PROVIDED IN INTEL'S TERMS AND CONDITIONS OF SALE FOR SUCH PRODUCTS, INTEL ASSUMES NO LIABILITY WHATSOEVER, AND INTEL DISCLAIMS ANY EXPRESS OR IMPLIED WARRANTY, RELATING TO SALE AND/OR USE OF INTEL PRODUCTS INCLUDING LIABILITY OR WARRANTIES RELATING TO FITNESS FOR A PARTICULAR PURPOSE, MERCHANTABILITY, OR INFRINGEMENT OF ANY PATENT, COPYRIGHT OR OTHER INTELLECTUAL PROPERTY RIGHT. Intel products are not intended for use in medical, life saving, or life sustaining applications. Intel may make changes to specifications and product descriptions at any time, without notice. Intel and the Intel logo are trademarks of Intel Corporation in the United States and/or other countries.

\* Other names and brands may be claimed as the property of others.  
Copyright © 2013, Intel Corporation. All rights reserved.

